

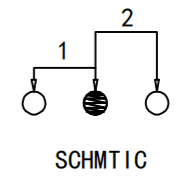

RoHS2.0
Compliant

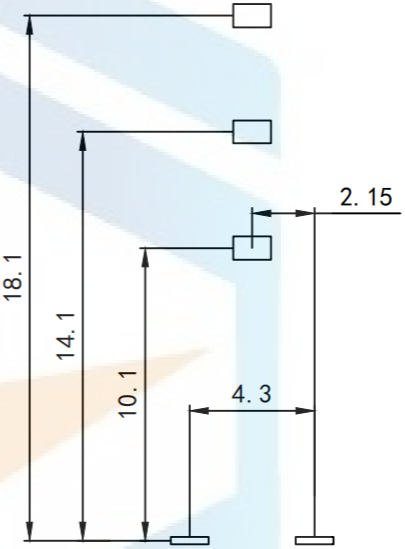
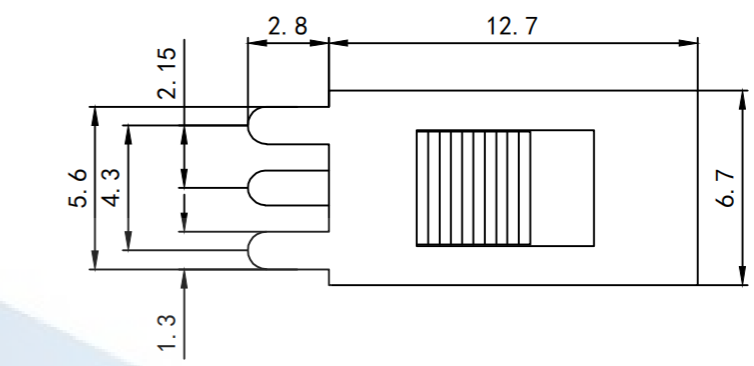
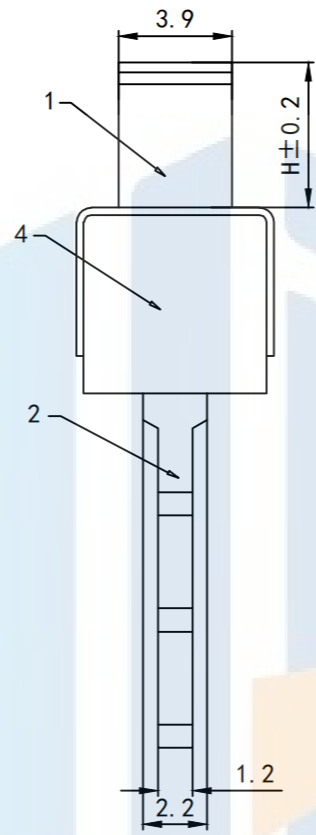
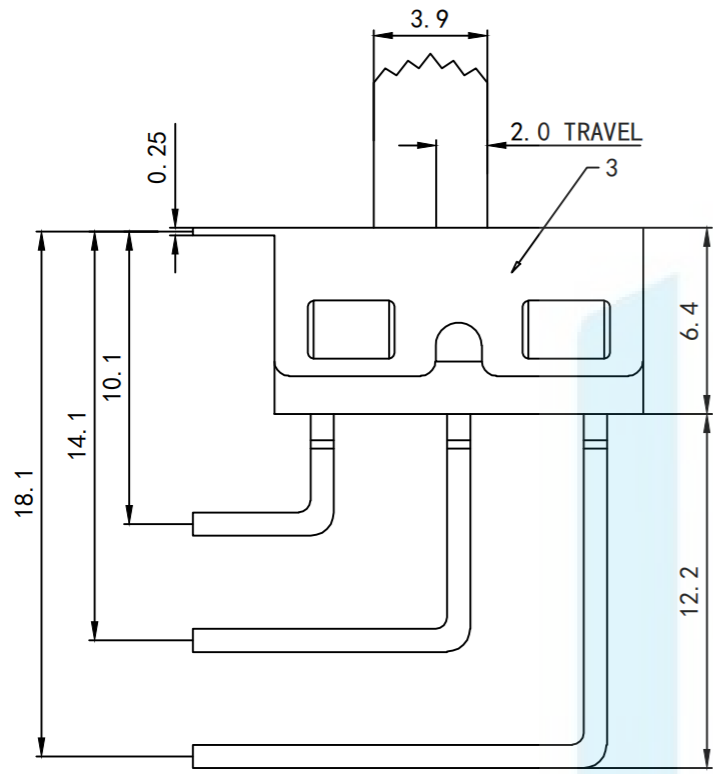
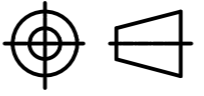

- Electrical performance parameter
1. Rated load :AC125V 3A
 2. Contact resistance: less than 100 milliohm
 3. Insulation resistance: more than 100 megohm
 4. Withstand voltage :AC 500V
 5. Strength :350 RMB 100gf
 6. Life :3000 times
 7. Wave peak welding :255 soil 5 degrees
 8. L=2-8

TOLERANCE X. XXX ±0.05 X. XX ±0.15 X. X ±0.20 X. ±0.30 ANGLE ±5.0°	 东莞市恒祺电子科技有限公司 Dongguan Hengqi Electronic Technology Co., Ltd	https://www.hq-dz.com		phone:15812872448	
		TITLE: 拨动开关		PART NO:SS-12D09	
PROTECTON 	DRAWN:		DATE: 18-10-08	UNIT: mm	
	CHECKED:		DATE: 18-10-08	SCALE: FULL	
	APPROVED:		DATE: 18-10-08	SIZE: A4	